

FEATURES:

- Direct operated directional control valve with hand lever operation.
- Valve mounting configuration according to national and international standard.
- Spring centered or spring offset for spool return to natural position or detent model available.
- Spool type design.
- Encapsulated structure for protect against dirt.
- Five chamber design for better reduction in dynamic forces and longer valve life.
- Mounting style Subplate body.
- Operating head can be rotated by 90°x4 around spool axis for flexibility in mounting.



TECHNICAL DATA:

Sr. No.	Characteristics	Technical Data
1.	Construction	Spool type
2.	Mounting	Subplate body Interface as per ISO 4401-AC-05-4-A and Is 10187-10 mm diameter nominal port
3.	Model code	Refer sheet no:- 4
4.	Mounting Position	Optional
5.	Flow direction	As per spool type
6.	Operating pressure	For port P, A & B..... 350 bar. For port T..... 100 bar. (both type)
7.	Hydraulic medium	Mineral oil
8.	Viscosity range	10 CST to 380 CST
9.	Fluid temperature range	-20°C to +70°C
10.	Fluid cleanliness requirement	As per ISO 16/13 or better
11.	Flow handling capacity	Refer performance curves.
12.	Mass	5.6 kg approx

SECTION:

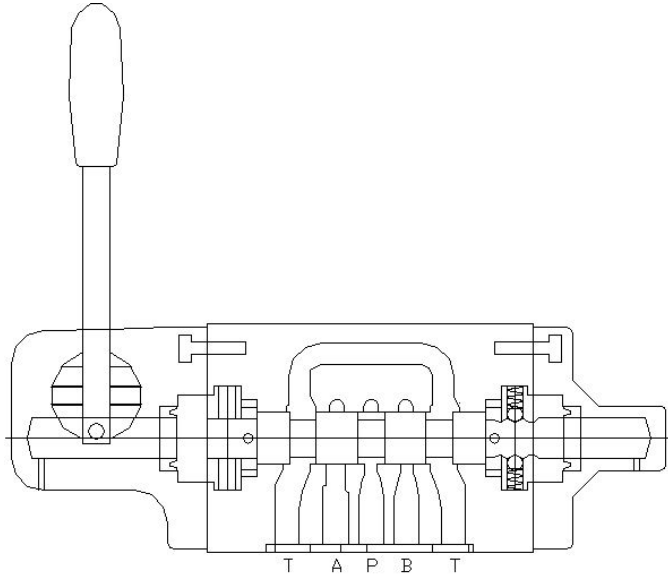

HYDRAULICS SYMBOL

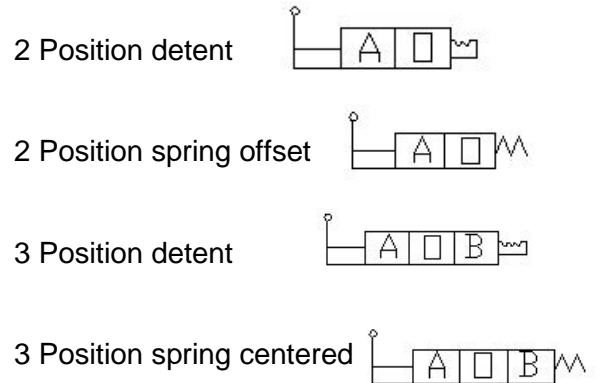

UNIT DIMENSIONS:

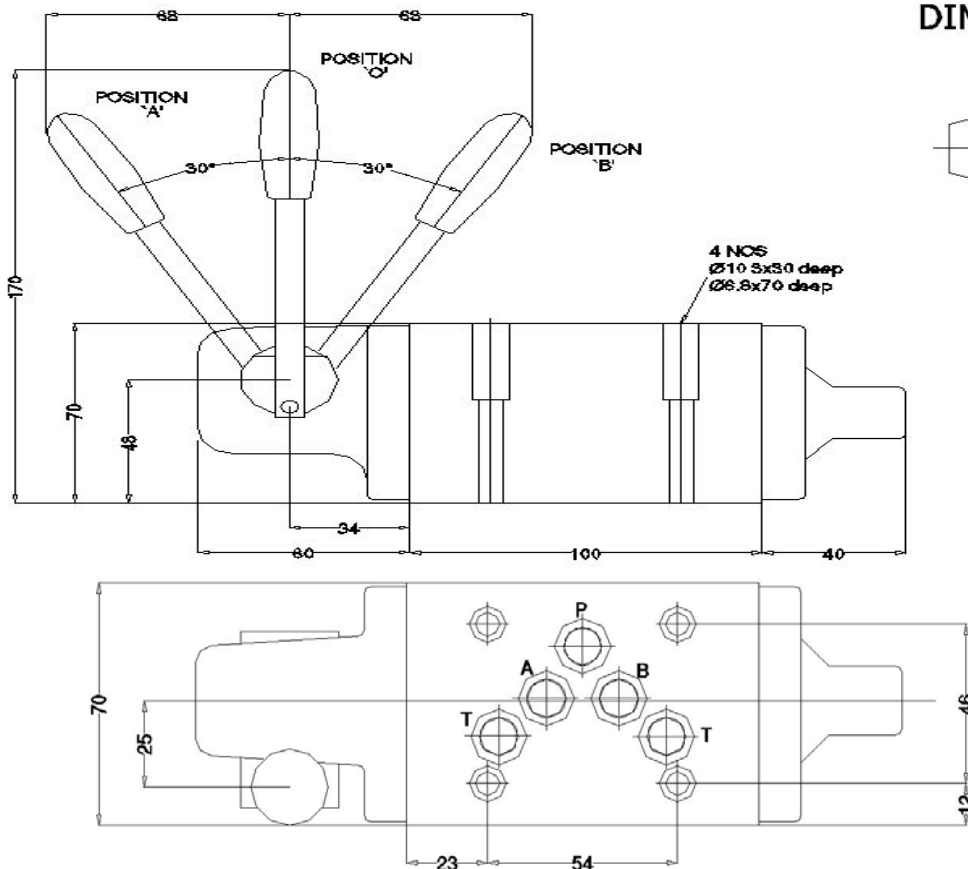

DIMENSIONS IN MM

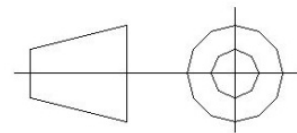

O'ring size at port P, A, B, and T IS 12 I.D. x 2

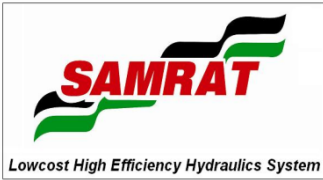

**DIRECTIONAL CONTROL
VALVE
Model: - DCL-*S**

3

Ref No. 031
Released 11/3/2015

PERFORMANCE CURVES:

Oil used ISO: VG 68, Viscosity: 68 CST @40°C, Temp. @ 50°C

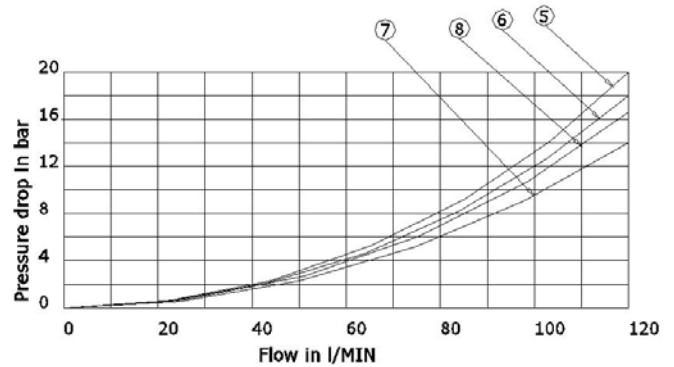
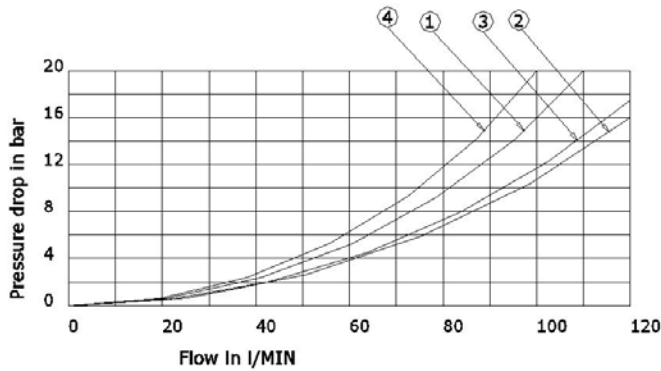

Table showing the relation between the spool type, Direction of flow and curves in the above graph to be referred to.

SPOOL TYPE	DIRECTION OF FLOW/ CURVES NO.				
	P TO T	P TO A	P TO B	A TO T	B TO T
A	---	1	2	---	---
C	---	1	1	2	3
E	---	1	1	2	3
F	4	1	1	7	3
G	4	1	1	2	3
H	5	6	6	7	3
J	---	1	1	7	8
L	---	1	1	7	8
M	---	6	6	2	3
P	4	1	1	2	8
Q	---	1	1	2	3
W	---	1	1	2	3

SAMRAT HYDRAULICS PVT. LTD.

Vavdi village road, Gondal Road, N.H., Survey No. 46,
Vavdi – 360004. Dist. RAJKOT (Gujarat - India)

MO: - +91 98243 96880

E-mail: samrathydraulics@gmail.com
Web: www.samrathydraulics.com



DIRECTIONAL CONTROL VALVE
Model: - DCL-*S

4

Ref No. 031
Released 11/3/2015

MODEL CODE:

DCL	*	10	*	*	11
-----	---	----	---	---	----

DCL= Directional Control Valve hand Lever operated

Valve Position
2= Two position
3= Three position

Size 10

Design code subjected to change but installation dimension remains same for design code 10 thru 19

Spool Position
D= Detension
S= spring centered for 3 position or spring offset for 2 position valves

Spool type
Refer table











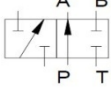
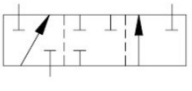
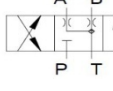
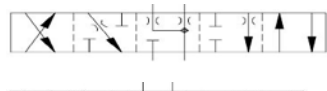



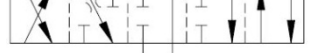
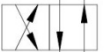
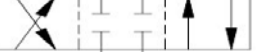
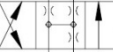

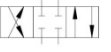
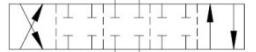

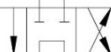

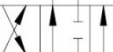

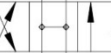
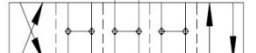
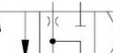



SAMRAT HYDRAULICS PVT. LTD.

Vavdi village road, Gondal Road, N.H., Survey No. 46,
Vavdi – 360004. Dist. RAJKOT (Gujarat - India)

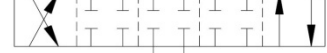
MO: - +91 98243 96880

E-mail: samrathydraulics@gmail.com
Web: www.samrathydraulics.com

SPOOL CHART:

TYPE	SYMBOL	CROSSOVER	TYPE	SYMBOL	CROSSOVER
	a 0 b A B P T			a 0 b A B P T	
A			Q		
C			U		
D			V		
E					
F					
G			S1		
H			S2		
J			S3		
L			S4		
N			S5		
P			S6	